



**KTH Architecture and
the Built Environment**

In-line rheology of cement grouts - Feasibility study of an ultrasound based non-invasive method

Mashuqur Rahman

Licentiate Thesis
Department of Civil and Architectural Engineering
Division of Soil and Rock Mechanics
KTH Royal Institute of Technology
Se- 100 44, Stockholm
Sweden
April, 2013

© Mashuqur Rahman 2013
Division of Soil and Rock Mechanics
Royal Institute of Technology (KTH)
TRITA-JOB LIC 2020
ISSN 1650-951X

Preface

The work presented in this thesis was performed at the Division of Soil and Rock Mechanics, KTH Royal Institute of Technology, and was supervised by Adj. Professor Ulf Håkansson. Funding for the project was provided by the Swedish Rock Engineering Research Foundation (BeFo), the Swedish Research Council (FORMAS) and the Development Fund of the Swedish Construction Industry (SBUF), who are gratefully acknowledged. The support from AtlasCopco in providing the LOGACTM flow meter, UNIGROUT E22H and CEMENTA AB in providing the cement grout is highly appreciated.

I am sincerely grateful to my supervisor, Ulf Håkansson, for initiating the project, for providing valuable support and for his encouragement and guidance. Laboratory work would not have been possible without the valuable support of my co supervisor, Johan Wiklund at the Swedish Institute for Food and Biotechnology (SIK). SIK staffs are acknowledged for their support during the experimental work. Special thanks to Professor Stefan Larsson for valuable advice and discussions. I would like to thank all of them for productive scientific discussions. Further acknowledgements are directed to my colleagues at the Division of Soil and Rock Mechanics.

Finally, my gratitude goes to my wife Ananna for her love and support and my family in Bangladesh for their encouragement.

Stockholm, April 2013
Mashuqur Rahman

Summary

Grouting is used in underground construction to reduce the water flow into tunnels and caverns and to limit the lowering of the surrounding groundwater table. Due to their wide availability and low cost relative to other materials, cement based materials are commonly used as grouts and, in this context, the rheology of the cement grout is an important factor. Rheological properties of cement grout such as viscosity and yield stress are commonly measured off-line using laboratory instruments, and some simple tools are available to make field measurements. However, these methods often lack accuracy and reliability. Although the rheological properties of the grout used play a fundamental role in design and execution, no method has yet been developed to measure these properties in-line in field work.

In this work, for the first time, an in-line rheometry method combining the Ultrasound Velocity Profiling (UVP) technique with Pressure Difference (PD) measurements, known as “UVP+PD”, was successfully tested for continuous in-line measurements of concentrated micro cement based grouts. The feasibility of using the UVP+PD method depends on the in-line determination of the rheological properties and time dependent behaviour of the cement grouts. A test set-up consisting of a combination of an experimental “flow loop” and a conventional field grouting rig – UNIGROUT E22H – from AtlasCopco, was used to investigate the feasibility of determining the rheological properties of cement grout using the UVP+PD method under field conditions. A laboratory based test set-up was used to further investigate the rheological properties in a more controlled environment.

The velocity profiles were measured directly in-line. The shape of the velocity profiles was visualized, and the change in the shape of the profiles with concentration and time was observed. The viscosity and yield stress of the grout were determined using rheological models, e.g. Bingham and Herschel-Bulkley. In addition, rheological properties were determined using the non-model approach (gradient method) and the tube viscometry concept and were compared with results obtained using the rheological models. In addition, the obtained rheological properties were subsequently compared with off-line measurements using a conventional rotational rheometer. The UVP+PD method was found to be capable of determining the true rheological behavior of cement grout regardless of the rheological model, providing the opportunity to visualize the change in the shape of the velocity profiles. Furthermore, it was possible to make an accurate determination of the velocity by ultrasound velocity profiling at a very flow rate (i.e. 1liter/min). The ultrasound velocity profiling was also found to be a reliable tool for determining the characteristics of the grout pump. In conclusion, the UVP+PD method was demonstrated to be a promising new in-line tool for determining the rheological properties of commonly used cement based grouts and the changes with concentration and time.

List of Publications

The licentiate thesis is based on work presented in the following publications:

- i. Håkansson, U., Rahman, M., Wiklund, J., 2012. In-line measurements of rheological properties of cement based grouts- Introducing the UVP+PD method. *In: Proceeding of 4th International Conference on Grouting and Deep Mixing, 16th-18th February New Orleans. ASCE, Geotechnical Special Publication No. 228, Vol. 1, 1023-1034.*
- ii. Wiklund, J., Rahman, M., Håkansson, U., 2012. In-line rheometry of micro cement based grouts - A promising new industrial application of the ultrasound based UVP+PD method. *Applied Rheology 22, 42783.*
- iii. Rahman, M., Håkansson, U., Wiklund, J., 2012. In-line rheological measurements of cement grouts: Effects of water/cement ratio and hydration. *Submitted to the journal Tunnelling and Underground Space Technology.*
- iv. Rahman, M., Håkansson, U., Wiklund, J., 2012. Grout pump characteristics evaluated with the Ultrasound Velocity profiling. *In: Proceeding of ISRM International Symposium, EUROCK, 28th-30th May 2012, Stockholm.*

Table of Contents

Preface.....	i
Summary	iii
List of Publications.....	v
1 Introduction	1
1.1 Previous studies.....	1
1.2 Objectives.....	3
1.3 Limitations.....	3
1.4 Outline of thesis.....	4
2 Background	7
2.1 Introduction	7
2.2 Rheology of cement grouts.....	7
2.2.1 Viscosity.....	8
2.2.2 Yield stress	8
2.2.3 Change in the rheological properties.....	9
2.3 Factors of influence.....	10
2.4 Measurement techniques	11
2.4.1 Laboratory measurement.....	11
2.4.2 Field measurement.....	12
3 Ultrasound methodology	13
3.1 Ultrasound Velocity Profiling (UVP).....	13
3.2 UVP+PD method.....	13
4 Experimental set-up.....	15
4.1 Experimental flow loop.....	15
4.2 UVP+PD instrumentation.....	16
4.2.1 Ultrasound transducers and flow cell	16
4.2.2 Instrumentation.....	18
4.3 Materials.....	18
5 Results	19
5.1 In-line measurement of the rheological properties of cement grout.....	19
5.2 Change in the rheological properties of cement grout with concentration and time	19
5.3 Determination of the volumetric flow rate	20
5.4 Grout pump characteristics.....	21

6 Conclusions and future outlook..... 23
7 References 25

1 Introduction

The process of injecting fluids that set in fractures or voids in a ground formation is called grouting. In underground constructions, grouting is performed to reduce the water inflow or to strengthen the ground conditions. It is important to eliminate or reduce excessive inflow of groundwater into e.g. a tunnel since lowering the groundwater table can create an adverse settlement of buildings in the vicinity of the tunnel or decrease the output of nearby wells. In general, the contractual requirements for grouting are becoming increasingly strict, mainly due to the fact that environmental considerations are now being taken more seriously in our society.

Due to their wide availability and lower cost, cement based materials are commonly used as grouts, and the rheology of the cement grout is an important factor. It is necessary to have an understanding of the grouting material in order to make a prediction of the outcome of the grouting (Hässler, 1991). The grouting design used in practice is mainly based on empirical knowledge and determination of the grout volume and pressure, in combination with an estimation of the yield stress of the grout used (Lombardi, 1985a). The rheological properties and selection of grout mix are considered to be important parameters for designing the grouting work. The selection of grout mix is also mainly based on experience; a stable grout mix was suggested by Lombardi and Deere (1993).

A comparatively recent grouting design approach based on determining the penetration length for cementitious grout in rock fractures and the characteristic grouting time has been developed (Gustafson and Stille, 2005). This methodology, called Real time Grouting Control (RTGC), for the design and control of a grouting operation, relies upon knowledge of the yield stress and viscosity, in addition to their change with time (Kobayashi et al., 2008), as shown in equation 1.

$$t_0 = \frac{6 \cdot \mu_g \cdot \Delta p}{\tau_0^2} \quad [1]$$

Thus, with knowledge of these parameters, a stipulated grouting time can be designed, provided that the yield stress and viscosity can be monitored in real time. The time dependency of the rheological properties of cement grout is not considered for grouting design in practice but is known to be an important factor (Håkansson, 1993). The need of an instrument capable of determining the rheological properties in-line has been emphasized for many years by different authors, e.g. Håkansson (1993), Barnes et al. (1989). However, although the rheological properties of cement based grouts play a fundamental role in grouting design, no method is yet available to measure these properties in-line during field grouting operations. Commercial grouting rigs used today are capable of measuring the pressure, grout flow and time during grouting operation. However, the rheological properties of the grout used are still measured off-line in the laboratory, and the results are often lacking in reliability and accuracy.

Ultrasound Velocity Profiling combined with Pressure Difference, known as the UVP+PD method, is a promising new tool for measuring the instantaneous velocity profiles and determining the rheological properties of cement grout directly in-line, and in real time. In this work, the UVP+PD method has been used to determine the rheological properties of cement grout directly in-line under field like conditions as well as in the laboratory.

1.1 Previous studies

Research on grouting has been continuously performed in Sweden for the last 25 years. However, significant implementation in grouting practice in the field is still lacking. The flow of grouts in jointed hard rock assuming a channel network was simulated by Hässler et al. (1992). The hydration of cement

grout and the inclination of the channel network were taken into account, and a significant difference in penetration was shown to be due to the time dependent properties of the cement grout.

Rheological properties of cement grouts were measured by Håkansson (1993) using different laboratory and field measurement techniques. It was shown that the determined yield stress and viscosity of the grouts used differ significantly depending on the measuring technique. The instruments used in the field were found to be rather simple, and the laboratory based instruments were lacking in reliability and robustness. Furthermore, different rheological models yield different values for the rheological properties. A field instrument, raise pipe, was developed to determine the yield stress, which can be used in combination with the marsh cone to determine the viscosity of the grout. The influence of the cement, bentonite as an additive and plasticizers on the rheological properties of cement grout was investigated. It was concluded that flow properties can be improved significantly by combining the plasticizers and bentonite in a cement grout (Håkansson et al., 1992).

Since filtration decreases the sealing efficiency significantly, numerical calculations of a grout spread for varying apertures were made by Eriksson et al. (2000). It was shown that the formation of a filter cake will increase the grout spread, although with a lower density and less sealing efficiency. In addition, the rheology of the cement grout will change accordingly. The variation in the yield stress and viscosity was investigated for different factors, e.g. w/c ratio, superplasticisers, mixing time, water temperature, field mixer. The significant difference in the viscosity and yield stress was found to be due to the w/c ratio and superplasticisers (Eriksson et al., 2004), and it was concluded that the rheological properties of cement grout vary significantly. In addition, they cannot be reliably determined.

The rheology of grout is important for sealing the conductive joint system of the rock mass. For a blocky rock mass with wide joints, efficient sealing can be achieved using a high viscosity grout; on the other hand, for crushed rock mass with narrow joints, efficient sealing can be achieved with a thinner grout with a longer grouting time. As a result, sealing of the rock mass joints is achieved by the combination of grouting time and grout rheology (Dalmalm, 2003).

Since the penetrability of cement grout in fractures smaller than than 50 microns is questionable, silica sol, a Newtonian fluid, was tested for a fracture with an aperture of 45-50 microns. For the same fracture, a penetration of 1 m was found with cement grout inj 30. While the theoretical model predicted a 2.2 m penetration length for silica sol, at least 1 m was found by visual observation. The sealing efficiency was found by the hydraulic tests to be satisfactory (Funehag and Fransson, 2006). The theoretical model was validated by physical demonstration and it was found that the actual penetration is strongly influenced by the viscosity of the silica sol. A higher penetration was achieved in the physical demonstration than what was predicted, which was most probably due to the wall slip (Funehag and Gustafson, 2008).

The concentration of cement grout, i.e. the water to cement ratio, is an important parameter for the stop mechanism of grouting and has an effect on penetrability and filtration. A thicker grout for a smaller aperture will cause filtration and form a filter cake. As a result, the pathway is gradually blocked. A higher water to cement ratio will provide a longer penetration and better sealing efficiency (Axelsson et al., 2009).

The penetration capability of grout with a water to cement ratio of 0.7-1.5 is divided in two parts, i.e. one based on rheology and the other on filtration tendency. The filtration tendency is the property of the grout to create a plug of cement grain in front of the crack opening. For a successful grouting operation and desired penetration, the grain size of the cement grout should be 4-10 times less than the aperture to be penetrated (Eklund and Stille, 2008).

Since filtration will reduce the sealing efficiency, factors affecting the filtration and penetrability of cement grouts were investigated. A laboratory based instrument, short slot, capable of changing the constriction of the geometry and visual control of the filter cake, was developed and used for the experiments. A higher concentration, i.e. a lower w/c ratio, yielded poor penetrability. Additives showed a positive effect on penetrability, although the effect of constriction was not clear from this study. It was shown that the best penetrability was achieved for a cement grout with a w/c ratio of 0.6 using inj 30 type of cement (Draganović and Stille, 2011).

1.2 Objectives

The main objective of this study was to verify the feasibility of the ultrasound velocity (UVP) method for measuring the velocity profiles of commonly used cement based grouts, continuously and directly in-line. In order to verify this method for field usage, a standard cement grouting equipment, UNIGROUT E22H and a LOGAC flow meter, were used to keep the conditions similar to what is used in practice. The velocity data were subsequently used to determine the rheological properties of grouts with different water-cement ratios. As a second step, the feasibility of using the UVP+PD method to determine the change of the rheological properties of cement grout with respect to concentration and time was investigated in the laboratory. Further objectives of the investigation were to determine the following:

1. Velocity profiles of cement based grouts for different water to cement ratios directly in-line using the customized flow loops
2. Rheological properties of cement based grouts by curve fitting to the velocity data achieved directly in-line
3. Shear rate, yield stress and viscosity of cement based grouts directly from the velocity profiles by the gradient method
4. Flow curves, i.e. shear stress vs. shear rate, of cement based grouts by the two different methods given above
5. Change of the rheological properties of cement grout with time using the Bingham model and Herschel-Bulkley model.
6. Change of the yield stress with time using a non-model approach, i.e. gradient method, tube viscometry concept and comparing the results with curve fitting approach
7. Volumetric flow rate directly in-line by using the UVP+PD method and comparing the results with a flow meter for field use (LOGAC) and a conventional electromagnetic flow meter
8. Compare the in-line results with the off-line measurements by a rotational rheometer

1.3 Limitations

The primary limitation concerning the application of the UVP+PD method for cement based grouts is the existing ultrasound transducer technology. Commercial transducers are often not capable of generating sufficient acoustic energy to measure the velocity profiles up to the center of the pipe, which is a

prerequisite for determining the rheological properties. However, custom made transducers were used in this work, and finding the optimum set-up was within the scope of this work.

Cement grouts were tested both with and without SetControl (SC). However, since the main objective was to determine the feasibility of the UVP+PD method for cement grout and its change with respect to time and concentration, no actual comparisons were within the scope of this work. The sampling time and other conditions were not identical, which means that the results with or without SetControl cannot readily be compared.

Off-line measurements were made using a conventional rotational rheometer. A time lag was inevitable during the sampling procedure from the in-line flow loop to the laboratory measurements, which implies that the sample was at rest for a certain period of time. As a result, the off-line measurements were not always under identical conditions, and comparisons with the in-line results should thus be made with caution.

1.4 Outline of thesis

This thesis starts with an introduction describing the necessity of determining the rheological properties of cement grout directly in-line and continues with a description of previous research studies on cement based grouts, concerning models of the penetration of cement grout in rock fractures, influence of the rheological properties and measuring techniques, and effect of filtration on the penetrability of cement grout.

The rheology of cement grout and different measurement techniques are discussed in chapter two and concern the yield stress and viscosity and their changes with time. Measurement techniques consist of different laboratory and field techniques, and their limitations are discussed.

The working principles of the UVP+PD method are described in chapter three. The methodology consists of two parts, ultrasound velocity profiling (UVP) and UVP combined with the pressure difference (PD), known as UVP + PD.

The experimental set-up and different equipment used for the experiments are presented in chapter four. The results are shown and discussed in chapter five. Conclusions follow in chapter six.

This research work resulted in several appended papers, which are briefly described below.

Paper I: Håkansson, U., Rahman, M., Wiklund, J., 2012. In-line measurements of rheological properties of cement based grouts- Introducing the UVP+PD method. *In: Proceeding of 4th International Conference on Grouting and Deep Mixing, 16th-18th February New Orleans. ASCE, Geotechnical Special Publication No. 228, Vol. 1, 1023-1034.*

This paper discusses different techniques for measuring the rheological properties of cement grout and the associated problems in existing techniques. This was a feasibility study, and the objective was to measure instantaneous velocity profiles and subsequently determine the yield stress and viscosity using different rheological models, e.g. Bingham and Herschel-Bulkley. The volumetric flow rate was determined by integrating the velocity profiles and was subsequently compared with the flow rate measured by the LOGAC™ device. A standard field grouting rig, UNIGROUT E22H, was used to keep the conditions, e.g. mixing, pumping etc., the same as they would be in the field. The feasibility study was successful, as it was possible to determine the rheological properties of cement grout using the UVP+PD method.

Paper II: Wiklund, J., Rahman, M., Håkansson, U., 2012. In-line rheometry of micro cement based grouts - A promising new industrial application of the ultrasound based UVP+PD method. *Applied Rheology* 22, 42783.

In this paper, rheological properties determined by the UVP+PD method are presented and compared with off-line measurements. The rheological properties were determined using rheological models, e.g. Bingham and Herschel Bulkley. In addition, a non-model approach, the gradient method, was used and presented. This is the first time the UVP+PD method was used for cement based grouts in field like conditions. It was possible to measure the velocity profiles up to the center of the pipe for w/c ratios of 0.6 and 0.8, which is a prerequisite for determining the rheological properties using the UVP+PD method. However, the results showed the requirement of an improved transducer design capable of generating sufficient energy for accurate measurements of the velocity profiles. Off-line measurements were made and found to be in good agreement with the in-line results. Volumetric flow rates were determined and subsequently compared with the commercial flow meter LOGACTM device. The UVP+PD method was found to be a promising tool for determining the rheological properties of cement grout in-line, under field like conditions, and capable of performing an accurate measurement and visualization of the flow rate.

Paper III: Rahman, M., Håkansson, U., Wiklund, J., 2012. In-line rheological measurements of cement grouts: Effects of water/cement ratio and hydration. *Submitted to the journal Tunnelling and Underground Space Technology*.

The work reported in this paper investigated the feasibility of the UVP+PD method for determining the change of the yield stress and viscosity of cement grout with respect to concentration and time. Yield stress and viscosity were determined using the Bingham and Herschel Bulkley rheological models. In addition, a non-model approach, gradient method and tube viscometry concept, was used and subsequently compared with the results obtained by the rheological model fitting procedure. A new non-invasive sensor unit was used and found to be capable of generating sufficient energy to measure the instantaneous velocity profiles beyond the center of the pipe for w/c ratios down to 0.6. A laboratory based flow loop was used to achieve a stable flow rate. The volumetric flow rate was determined by integrating the velocity profiles and was subsequently compared with the LOGACTM commercial flow meter and an electromagnetic flow meter. The UVP+PD method was capable of determining the change of the rheological properties of cement grout with respect to concentration and time directly in-line. In addition, it was found to be an effective tool for visualization and accurate flow measurement.

Paper IV: Rahman, M., Håkansson, U., Wiklund, J., 2012. Grout pump characteristics evaluated with the Ultrasound Velocity profiling. *In: Proceeding of ISRM International Symposium, EUROCK, 28th-30th May 2012, Stockholm*.

In this paper, the Ultrasound Velocity Profiling (UVP) technique was shown to be an effective tool for determining the characteristics of the grout pump. A standard grouting rig, UNIGROUT E22H and a laboratory based set-up with a progressive cavity type of pump, was used and the instantaneous velocity profiles were measured. A large fluctuation in the velocity was observed due to the piston type of pump used in the grouting rig. Negative velocity was also observed which was due to the backstroke of the piston. This is a unique feature of the UVP which is not possible to obtain by other methods. In contrast

and as expected, the progressive cavity type pump provided a very stable flow rate. Based on the visualization of the pulsed flow, characteristics of the grout pump can be determined and optimized for practical grouting. In addition, UVP was found capable of making accurate determinations of the flow rate when it is less than 1 liter/min, which is not possible using commercial flow meters. Since field grouting work is based on empirical methods and the determination of the flow and pressure, a device capable of making accurate measurements of the flow rate would lead to a better determination of the execution time in grouting practice.

2 Background

2.1 Introduction

Rheology is the science of deformation and the flow of matter. The word ‘rheology’ was created by Professor Bingham of Lafayette College. The study of rheology was rather slow and occasional until the early decades of the twentieth century. However, during the Second World War, rheology came to be an emerging force to be dealt with in the synthetic fibre and plastic processing industries (Barnes et al., 1989).

2.2 Rheology of cement grouts

The rheological behavior of cement based grout is considered complex (Håkansson, 1993). The grout is non-Newtonian and thixotropic and consists of a yield stress. Further, the hydration of the cement also plays a key role, as the rheological properties change with time. The rheology of cement grout is a factor of prime importance regarding the transporting, pumping, pouring and spreading of the material. In practice, cement grouts with water to cement ratios of 0.6-1.5, consisting of a solid volume concentration of approximately 30%-50%, are used (Rosquoët et al., 2003). In concrete, the shear rate increases with the aggregate content, and a complete breakdown is achievable at the end of mixing. In contrast, for cement grouts, due to the absence of aggregate, the surface area of the finer cement particle is higher and the rheology is more complex as a result of the interaction between the suspended particles and the breakdown during shearing. Typical values of the rheological properties of the cement based materials are summarized by Banfill (2003) and are shown in Table 1.

Table 1 Typical values of the rheological properties of cement based material, Banfill (2003)

Material	Cement paste, Grout	Mortar	Flowing concrete	Self-compacting Concrete	Concrete
Yield stress N/m ²	10-100	80-400	400	50-200	500-2000
Plastic viscosity Pa.s	0.01-1	1-3	20	20-100	50-100
Structural Breakdown	Significant	Slight	None	None	None

The rheological properties of cement based materials are determined by a mathematical curve fitting to the shear stress vs. shear rate curves. There can be disagreements between the results obtained using different mathematical models and reported in different research work, e.g. Yahia and Khayat (2003), Nehdi and Rahman (2004). The Bingham model is widely used owing to its simplicity and the linear relationship between shear stress and shear rate. However, the rheological behavior of dense cement based materials could be better explained by the Herschel-Bulkley model since it can explain the shear thinning behavior that is observed (Larrard et al., 1998). The Bingham model and the Herschel Bulkley model are given as:

$$\text{Bingham : } \tau = \tau_0 + \mu \dot{\gamma} \quad [2]$$

$$\text{Herschel-Bulkley : } \tau = \tau_0 + k \dot{\gamma}^n \quad [3]$$

As can be seen, both of the models exhibit a yield stress. In the Bingham model, the viscosity is expressed by a linear relationship with the shear rate while, in the Herschel-Bulkley model, apart from the yield stress, the shear thinning behavior is represented by the flow index n . The inter-particle forces between the cement suspension are the origin of the yield stress, which are partially dependent on time and the shear history. The degree of interaction depends on the concentration, particle size and surface properties. The interaction causes a flocculation which plays an important role in the rheological properties of the cement suspension and penetration of the grout. At high shearing, the flocculation can be reduced. However, re-flocculation and thickening will occur when the suspension comes to rest. These phenomena are known as structural breakdown and build up or thixotropy.

From a grouting point of view, the rock fracture geometry is hardly known. As a result, there is not much importance of a sophisticated rheological model. Use of rheological models consisting of yield stress is convenient and it is sufficient to use the Bingham model. The flow rate and the filling capacity of the cement based mixture depend on the yield stress. Yield stress is very important for cement mixtures set without vibration. As a consequence, yield stress can be referred as the quality control index (Yahia and Khayat, 2001).

2.2.1 Viscosity

Viscosity is considered to be the most important material property. Any practical study investigating the material response will eventually lead to the viscous behavior of the material (Barnes et al., 1989). Viscosity is the relationship between shear rate and the stress applied on the material. In the case of Newtonian behavior, viscosity is independent of the shear rate. However, for non-Newtonian behavior, it is referred to as ‘apparent viscosity’ or ‘shear rate dependent viscosity’. A variation in the viscosity can be observed with changes of temperature and pressure. Cement grouts and cement based materials are subject to hydration, and the viscosity changes accordingly. As observed by Håkansson (1993) and summarized by Banfill (2006) and Sant et al. (2008), hydration proceeds in several stages. The first stage involves a rapid reaction between the anhydrous minerals and water, resulting in a wetting peak. Subsequently, a slow reaction for two or more hours known as the dormant period is followed by an accelerated stage responsible for interlocking. Finally, the fourth stage involves the deceleration process. As a consequence, the viscosity of the cement based materials will change in accordance with the hydration process. However, determination of the plastic viscosity and the consistency index, K , by the Bingham and Herschel-Bulkley models might also yield different results for the same sample due to the shear rate range of the mathematical fitting. As shown by e.g. Nehdi and Rahman (2004), the Bingham model will always yield a higher viscosity than other rheological models, e.g. the Casson model.

2.2.2 Yield stress

The yield stress is regarded as the material property that denotes the transition between solid like and fluid like behavior. Consequently, it is the minimum stress that makes the fluid flow like a viscous material. Inter-particle forces between the solids in a suspension result in a yield stress that must be overcome to start the flow. In addition, an applied stress that is lower than the yield stress will result in a deformation like a solid instead of flowing. The existence of a yield stress has been questioned by some authors, e.g. Barnes and Walters (1985), due to the fact that, given accurate measurements at very low shear rates, no yield stress exists. In this work, two Newtonian plateaus were observed at the very low and high shear

rates, and the rest of the region showed a power law behavior. No yield stress was achieved for a shear rate range of 10^{-3} - 10^{-5} s⁻¹. The historical concept of yield stress was summarized by Barnes (1999), and the long argument on the existence of yield stress was concluded by the fact that it is acceptable to describe the material behavior with a yield stress over a limited shear rate range; however, this is represented by limited data. It was summarized that the yield stress might be misunderstood because of the wall depletion effect, which shows a Newtonian plateau at the low shear rate. However, the removal of the wall depletion would lead to a flow curve without any yield stress consisting of a lower-higher shear rate Newtonian plateau. The yield stress is measured using different type of viscometers, e.g. rotational, cone and plate, tube etc. As shown by Mannheimer (1991), the wall slip effect is a major problem when measuring the yield stress of cement slurries, especially at the lower shear rates. When using the Couette geometry of the rotational viscometer, 100% wall slip was observed for a mean shear stress of less than 20 Pa. Furthermore, a 100% wall slip was observed when the tube viscometer used had the same roughness for a mean shear of less than 28 Pa. A Newtonian viscosity at the lower shear rates was observed that was the result of wall slip; however the correction for the slip represented a material behavior including a yield stress. Cement suspensions with strong particle interactions have been reported to have a dynamic yield stress in addition to the static yield stress at zero shear rate due to their thixotropic nature. The static yield stress was referred to as the 'gel strength' (Keating and Hannant, 1989). The dynamic yield stress would be less than the gel strength due to the fact that the slurry breaks down under shearing when it exceeds the gel strength. Consequently, a continuously increasing deformation will take place when the shear stress exceeds the dynamic yield stress. To measure the yield stress of concentrated suspensions, both direct and indirect methods have been proposed and performed (Nguyen and Boger, 1983). Constitutive equations and rheological models are used to extrapolate the resulting fitted curve to zero shear rates, since it is not possible to obtain the shear stress at zero shear rate using conventional rotational viscometers. To make the grout suitable for practical use, high range water reducers (HRWR), viscosity enhancing admixtures (VEA) and rheology modifying admixtures (RMA) are used to change the rheological behavior of the grouts. According to the author's understanding, these admixtures are known to the grouting industry as plasticizers or super-plasticizers. RMA is used with high performance grout to increase the resistance against wash out, bleeding and sedimentation. Moreover, these admixtures have an effect on the yield stress. When using the analytical models to determine the yield stress of the grout, it should be noted that different models will yield different results depending on the shear history of the material (Yahia and Khayat, 2003).

2.2.3 Change in the rheological properties

The rheological behavior of cement based grouts changes with time. The change in the rheological properties can be described by the terms thixotropy and hydration. Thixotropy is the material property that is responsible for the solidification of gels, which may again be liquefied to sols. Provided that there is constant temperature and shear rate, the solidification happens repeatedly. However, thixotropy can also be explained by the fact that the viscosity of a material increases when it is at rest and decreases with an increase in the shear stress. The history and the definitions of thixotropy have been summarized by Barnes (1997). What is implied is a decrease in shear stress at constant shear rate or an increase in shear rate at constant shear stress. Moreover, the phenomenon of thixotropy can be observed by a hysteresis loop in the shear stress-shear rate curve of a cement suspension. Since the flocculated structures are broken down, a down curve, i.e. a decrease in shear stress at the same shear rate compared to the up curve, will be observed. The structural breakdown refers to the process of breaking certain linkages between the cement particles, which were assumed to be formed by the hydration process. The true thixotropic behavior of

cement paste, e.g. coagulation, dispersion and re-coagulation of the cement particles, plays a major role in generating the time dependent behavior. The particles are assumed to have a linkage that is broken during this process. Based on this assumption, a material model (PFI – Particle Flow Interaction model) to simulate the rheological behavior of cement paste was proposed by Wallevik (2009). The coagulation process is due to the potential energy of the particles, which ‘glue’ them together when they come into contact with each other for a certain duration of time. However, this coagulation can be referred as ‘reversible’ and ‘irreversible’ depending on the breakage of the linkage of the particles. The time dependent shear response of cement paste with a low water to cement ratio was shown by Sant et al. (2008). At an early stage, the shear stress was observed to reach equilibrium after a peak shear stress. However, at a later stage, the shear stress increased rapidly and the measured shear stress exhibited a saw-tooth response. This can be explained by the continuous loss and recovery of inter-particle forces under the applied stress. Besides in cement, thixotropic behavior was observed in Bauxite residue (Nguyen and Boger, 1985). The yield stress decreased over time and an equilibrium state was achieved while shearing for a longer period. In addition, the recovery time was very high when the suspension was at rest, which showed an irreversible thixotropic structure associated with the red mud suspension. This was explained by the fact that two types of bonds were present in the system, the inter-particle bond and the inter-aggregate bond. While the suspension was under shear, an applied stress higher than the yield stress broke the inter-aggregate bonds in an irreversible manner and the inter-particle bonds were broken in a reversible manner. An equilibrium of yield stress over longer shearing period indicated that the aggregate structure cannot be destroyed by prolonged shearing but will rest at a certain level. As summarized by Banfill (2006), the practical significance of the thixotropy in cement systems lies in the rapid structural build-up that reduces the exerted pressure by self-compacting concrete in formwork. In addition, the rapid stiffening of the sprayed concrete prevents it from slumping before setting. Further, thixotropic slurries have been found problematic in connection with flow in pipes. When flowing through a pipe, the liquid near the pipe wall will be highly sheared and will be subjected to rapid and prolonged breakdown. As a result, a lower viscosity will prevail near the pipe wall. However, at the center of the pipe, the shearing will be lower; hence an inner, more viscous layer would be present.

The rheological properties of cement suspensions change over time due to hydration. Hydration results in a chemical shrinkage in cement paste and develops in several stages. The hydration starts with a wetting peak, after which follows a dormant period. An accelerated period is subsequently observed, followed by a decelerating period, which ends with the steady state period. The determination of the yield stress and viscosity of cement paste and grout shows a similar trend. As shown by Håkansson (1993) and Sant et al. (2008), the yield stress increases with time and then becomes dormant for a period of time.

2.3 Factors of influence

The rheology of cement based grout is complex in comparison with that of concrete due to the absence of aggregate and since the structural breakdown is not pronounced (Håkansson, 1993) . A shear thinning behavior originates from the particle size, shape distribution and water to cement ratio. Moreover, a yield stress and a thixotropic time dependent behavior due to the reversible breakdown of the particle structure under shearing are exhibited. Gravitational sedimentation, flocculation due to inter-particle forces and particle mitigation due to the velocity gradient are other complicating factors. Factors affecting the rheological properties of cement grouts can be summarized as water to cement ratio, cement type (fineness, particle size and distribution), admixtures (e.g. superplasticisers, sodium silicate and calcium chloride), additives (bentonite and silica fume), hydration (i.e. time from mixing with water) and temperature (Håkansson et al., 1992).

Using micro fine cements is regular practice in the grouting industry to increase the penetrability into fine rock fractures. The water to cement ratio and the use of superplasticisers are factors of major importance when using these types of cements. On the other hand, use of additives and admixtures has become more or less outdated. When using superplasticisers, however, it should be noted that the effect will be limited in time and becomes less significant after approximately 30 minutes. The effect of cement hydration will take some time before having an influence, and the dormant period usually lasts a few hours. A decrease in temperature will increase the viscosity, although the effect is not significant in normal temperature ranges used in practice.

2.4 Measurement techniques

Measurements of the rheological properties of cement based grouts are made in the laboratory and in the field. Instruments that are used in the laboratory are not robust, and instruments that are used in the field are rather primitive and their results might be unreliable and difficult to reproduce (Håkansson and Rahman, 2009).

2.4.1 Laboratory measurement

Laboratory measurements are made using different types of rotational and tube viscometers. Rheological properties can be measured by rotational viscometers using indirect and direct techniques. As mentioned by Nguyen and Boger (1983), the indirect methods can be referred to as the direct extrapolation of the rheological shear rate-shear stress data, i.e. extrapolation of the flow curves assuming different rheological models. Direct methods are for example the shear stress relaxation method and the shear vane method.

When measuring the rheological properties of cement grout using the rotational viscometer, the concentric cylinder geometry is often used. The advantage is that this geometry requires only a small sample that can be measured for a longer period of time. However, a measurement with the concentric cylinder geometry should be performed with care since the wall slip phenomenon is inevitable when measuring a shear thinning thixotropic fluid (Barnes, 1995). The wall slip occurs due to the displacement of the disperse phase (concentrated suspension) away from the solid boundary, leaving a low viscous layer near the smooth wall. Since cement based suspensions also generate flocks, a comparatively larger gap is required when using the concentric cylinder geometry, which paradoxically leads to a larger slip effect. However, the slip can be reduced by roughening the wall surfaces.

To eliminate the wall slip effect, Nguyen and Boger (1983) introduced the vane method. Different measurement geometries were used, e.g. a concentric cylinder, and the complexity associated with the measurement at low shear rates and the model fitted parameters was discussed. The significance of measuring the shear stress-shear rate data by a direct method was stressed. The measurement with the vane geometry is independent of the vane dimension and size and was shown to be more accurate for highly concentrated thixotropic suspensions. A further work by Nguyen and Boger (1987) showed that, when measuring a concentrated suspension of thixotropic material using the concentric cylinder, the sample might be partially sheared due to the yield stress. Moreover, the measured shear stress will also depend on the rotational speed of the bob that is applied. Besides the effect of the applied rotational speed, the measured shear rate will differ due to the time dependent behavior of the sample material.

Tube viscometers are the most commonly used instruments for measuring viscosity due to their low cost and simplicity. When a fluid is driven by pressure through a pipe, the velocity is at its maximum at the

center, which implies that the velocity gradient or shear rate is at its maximum at the pipe wall and zero at the center. The wall shear stress is obtained from the pressure difference over a known distance. The shear rate is determined assuming a Newtonian fluid, and a correction factor, e.g. Rabinowitsch–Mooney, is applied to determine the shear rate for a non-Newtonian fluid. As a result, the wall shear stress vs. wall shear rate curve is obtained, provided that pipes with different diameters with the same L/R ratio are used. The wall slip phenomenon is evident for cement grout when tube viscometers are used. A cement layer is depleted at the pipe wall, and the smooth surface provides a lower viscosity of the grout. The wall shear rate should therefore be corrected because of the slip. More detail on tube viscometry can be found in Mannheimer (1991), Barnes (1999).

2.4.2 Field measurement

Rheological properties of cement grout are commonly measured in the field by simple instruments, such as a Marsh cone and yield stick. The Marsh cone is used to measure the fluidity of cement grouts in the field. In fact, this is a workability test to check the specification and control the quality of cement pastes and grouts. The longer the time necessary for the grout to flow out of the cone, the lower the fluidity. The flow time of the grout can be correlated with the viscosity assuming a Bingham plastic material, provided that the yield stress and density of the grout is known. The yield stress can be determined by the ‘raise pipe’. Here the grout is intruded into a vertical raise pipe, and the principle is that the flow stops when the maximum shear stress at the pipe wall is below the yield stress. The density of the fluid must be known for this test (Håkansson et al., 1992). In addition, the yield stress can be measured by the yield stick in the field (Axelsson and Gustafson, 2006). Experiments were performed on crushed dolomite type grouting material and cement grout with w/c ratios of 0.8-2.0. In comparison to the rotational rheometers, the yield stick provided slightly lower yield stress values. It was concluded that the yield stick can be used as a robust method to determine the yield stress of cement grout in the field. In addition, it can be combined with the marsh cone to determine the viscosity of the grout. Referring to the yield stress as cohesion, a simple instrument, called the plate cohesion meter, was introduced by Lombardi (1985b). A thin steel plate with a rough surface to which the grout can stick is submerged into the grout. If the specific weight and the amount of the grout that sticks on the plate are known, the cohesion per unit weight can be determined. Although these methods are used in the field, the results obtained are often lacking in accuracy and reliability (Håkansson et al., 1992).

3 Ultrasound methodology

3.1 Ultrasound Velocity Profiling (UVP)

Ultrasound Velocity Profiling (UVP) is a technique originally developed in medicine to measure blood flow. This method was subsequently extended by Takeda (1986) for application in fields of engineering. The principles of ultrasound Doppler velocity profiling are discussed in detail in the literature; see for example Takeda (1995). The working principle is based on the emission of pulsed ultrasound bursts and echo reception along the beam axis. The ultrasound transducer is placed at an angle with respect to the pipe wall and emits short bursts of ultrasound waves before switching to receiving mode. When the ultrasound waves hit a scattering particle, parts of the ultrasound energy scatter on the surface of the particle and echo back towards the transducer. The echo reaches the transducer after a certain time delay. If the scattering particle is moving with a non-zero velocity component into the acoustic axis of the transducer, the received signal's frequency will be different compared to the emitting frequency due to Doppler shift taking place. The local velocity of the suspended particles inside the beam axis is analyzed from the echo signals originating from several time delays or distances from the transducer.

3.2 UVP+PD method

The basis of the UVP+PD comes from the pipe viscometry concept. The working principle of pipe and capillary viscometers can be derived from a force balance over a cylindrical fluid element in fully developed, steady state, laminar flow in a pipe. Single point rheological parameters are obtained from the pressure drop and volumetric flow rate. The UVP+PD instrument is basically a tube viscometer with multi-point measurement.

This method can be used for continuous determination of various rheological parameters. The concept of combining UVP with PD was proposed in the 1990s when the UVP-DUO-MX monitor from Met-Flow, Lausanne, Switzerland, became commercially available. The limitation of the capillary viscometer instrument is that it only provides single point data corresponding to a specific shear rate, hence limiting its use for non-Newtonian fluids. The UVP+PD method developed at SIK, the Swedish Institute for Food and Biotechnology, allows real-time measurements of radial velocity profiles and hence complete flow curves. From the derived data, rheological properties such as viscosity and yield stress can be determined directly in-line. The potential of this method for measuring the rheological properties of cement grouts was discussed by Håkansson and Rahman (2009) and the feasibility of this method was investigated by Håkansson et al. (2012) and Wiklund et al. (2012a). It was subsequently found that the UVP technique itself can be a very good method for evaluating the grout pump characteristics with respect to pulsation (Rahman et al., 2012). The UVP+PD technique has also been successfully used in various other industrial suspensions, such as food, paper pulp and mine tailings, e.g. Birkhofer, (2007), Kotzé et al., (2008), Wiklund and Stading (2008), Wiklund et al. (2007) and Wiklund et al. (2006).

The true rheological properties, regardless of the rheological model, can be determined by the gradient method, which is a unique feature available in the UVP+PD method. The shear rate is calculated from the gradient of the velocity profiles, and the yield stress is determined from the plug radius. However, the gradient method is sensitive to noise and requires an accurate measurement of the velocity profiles.

The procedure of the determination of rheological properties by the UVP+PD method is shown in figure 1.

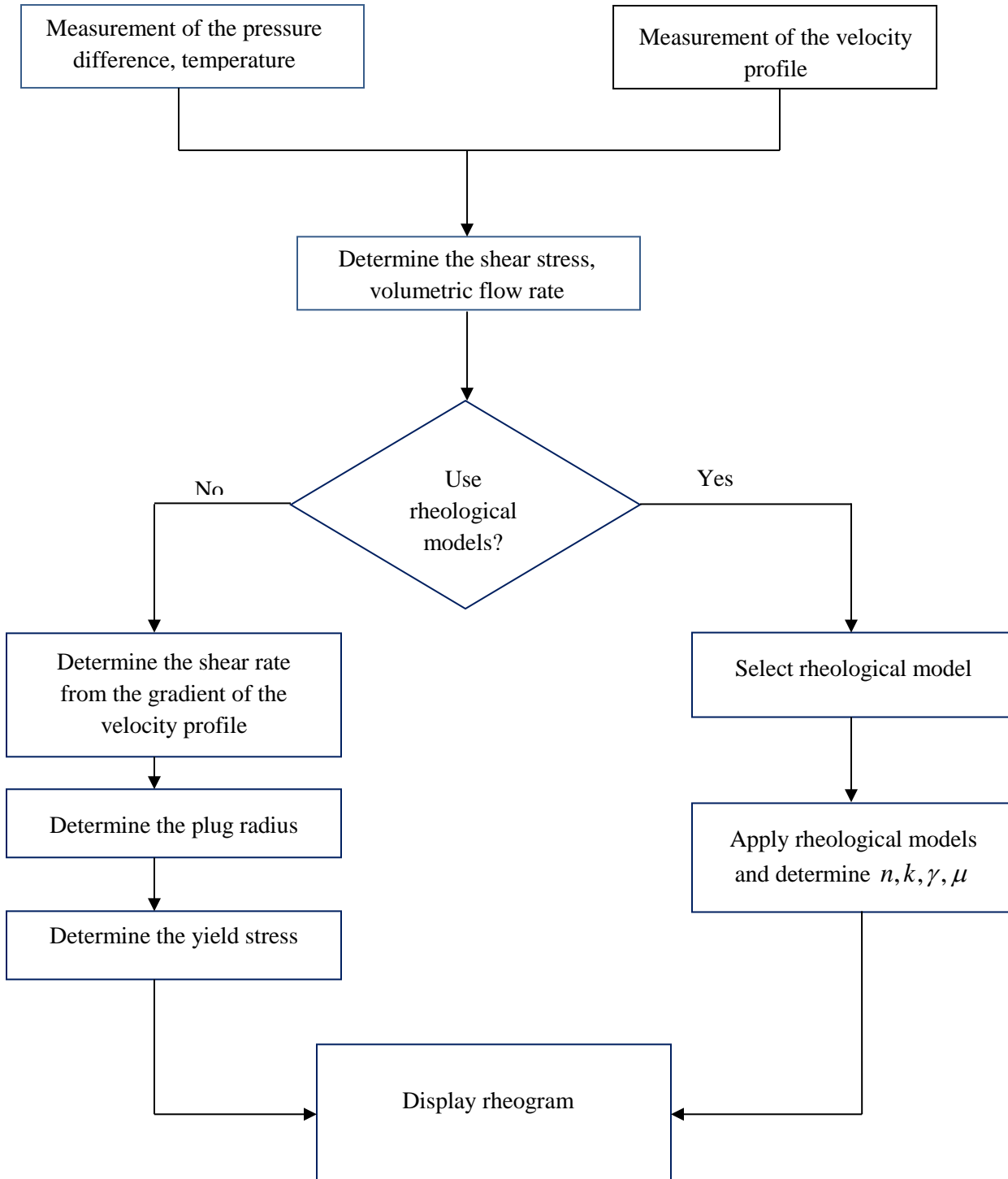

Figure 1 Rheological properties determination flow chart using the UVP+PD method

4 Experimental set-up

4.1 Experimental flow loop

Two different types of experimental set-ups were used for the field like and laboratory based conditions. The standard grouting machine, UNIGROUT E22H from Atlas Copco, was used to keep conditions the same as in the field. The flow was circulated through a flow loop consisting of a standard grouting rig, UNIGROUT E22H, UVP+PD test section and LOGACTM flow/pressure meter. LOGACTM was used as a reference for the flow rate determined by UVP. The experimental set-up used for the field like conditions is shown in figure 2.

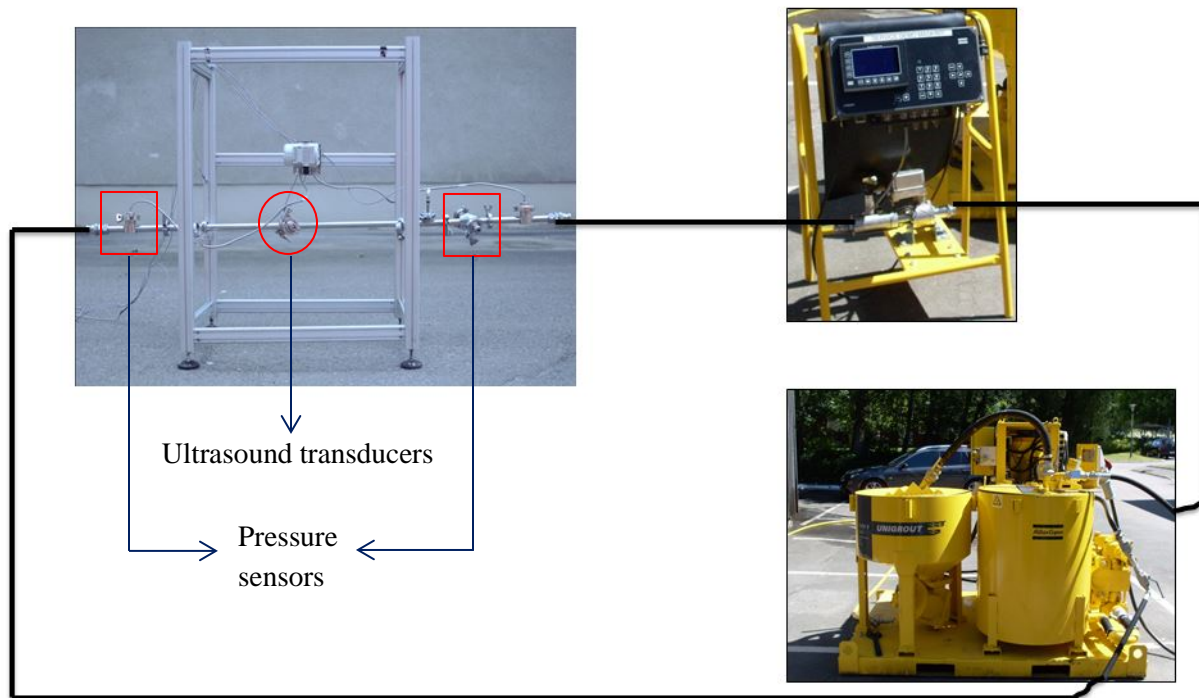

Figure 2 Experimental set-up used for the field like conditions

A laboratory based flow loop was designed consisting of a helical rotor progressive cavity type of pump to achieve a stable flowing condition during the measurement of the flow and the determination of the rheological properties. The flow was circulated through a flow loop consisting of a storage tank, a progressive cavity single screw pump, the UVP+PD test section, LOGACTM flow meter and temperature sensors. The objective was to obtain a steady flow using a progressive cavity pump and a simpler set-up by excluding the UNIGROUT E22H. A schematic illustration of the experimental set-up is shown in figure 3.

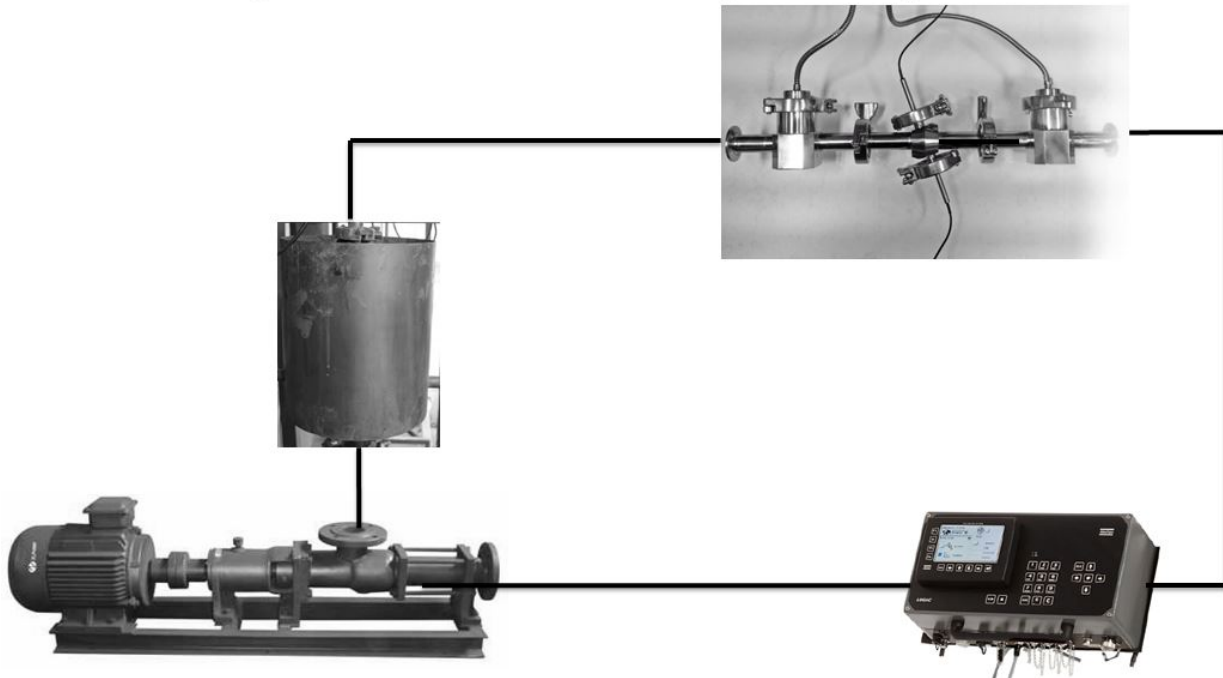

Figure 3 Experimental set-up used for the laboratory based conditions

4.2 UVP+PD instrumentation

4.2.1 Ultrasound transducers and flow cell

Two different types of ultrasound transducers were used in this project. Cement grout is an attenuating material and standard commercial transducers are not capable of emitting sufficient acoustic energy to measure the velocity profile until the center of the pipe. For this reason, custom made delay ultrasound transducers were used. Delay line is a material fixed ached of the transducers which reduces the near field distance. As a result, velocity profiles just in front of the transducer face can be measured. A flow adapter cell was developed and fitted with one pair of custom made delay line 4 MHz transducers. The inner diameter of the flow adapter was 22.5 mm. The flow adapter material was stainless steel. Transducers were mounted in flush with the pipe through the cavities with diameter equal to the housing diameter of the transducers. Transducers were installed at a distance equal to the near field distance to avoid the near field region where the ultrasound field is highly irregular. The flow adapter and transducer installation used for this experiment is shown in figure 4.

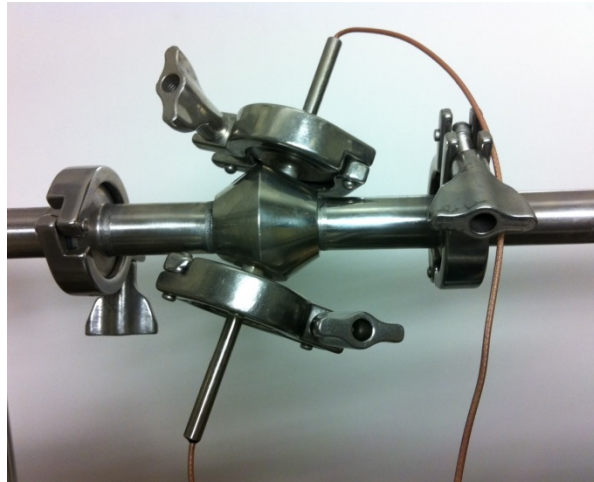

Figure 4 Flow adapter cell consisting of delay line ultrasound transducers

For the experiments carried out in field like conditions, two 4 MHz ultrasound transducers (TR0405LH-X, Signal-Processing SA, Savigny, Switzerland), high temperature, were fitted with the flow adapter. These transducers allow measurements directly from the transducer front, implying that more or less zero velocity at the wall can be recorded. The active and outer diameters of the transducers are 5 mm and 8 mm, respectively. The transducers were fixed inside the flow adapter in the horizontal plane to minimize the sedimentation effect and were placed opposite to each other with a Doppler angle.

However, delay line transducers might often lack on the emitted acoustic energy and robustness (Rahman et al., 2012). As a consequence, a robust, non-invasive ultrasound sensor unit, capable of emitting sufficient acoustic energy, mounting outside of the stainless steel pipe was required. For the experiments in laboratory based conditions, a novel non-invasive sensor unit was developed that consists of ultrasound transducers, wedges, absorbers, and acoustic couplants. This was the first time experiments were performed to measure a profile non-invasively through high grade stainless steel. The 3D-model of the non-invasive sensor unit with mounting device is shown in figure 5.

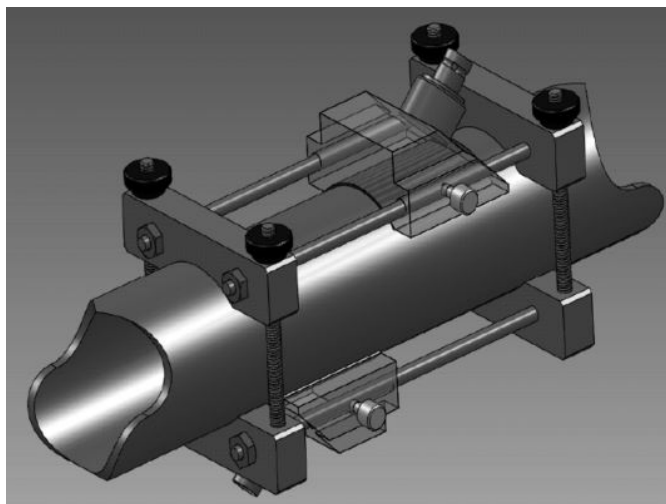

Figure 5 3D model of the non-invasive sensor with mounting device (Wiklund et al., 2012b)

4.2.2 Instrumentation

The velocity profile measurements were made with a pulser/receiver instrument, the UVP-DUO MX (Met-Flow, SA, Lusanne, Switzerland) model with a multiplexer. The instrument firmware and driver software were modified to allow access to the demodulated echo amplitude data (DMEA; raw data that can not be obtained using standard instruments). The UVP Duo instrument and other hardware devices were connected to a master PC via Ethernet and a DAQ card (National Instruments, ABB). MatLab based software with a graphical user interface (Rheoflow) was used to control all hardware devices for data acquisition, signal processing, visualization of the data and real time monitoring of the rheological properties. UVP data acquisition was implemented using an active X library (Met-Flow, SA). A high speed digitizer card (Agilent Acquiris) was used as an integral part of the data acquisition scheme, enabling simultaneous measurements of the velocity profiles and acoustic properties.

Two differential pressure sensors (ABB 256DS, ETP80, ABB Automation Technology Products AB, Sollentuna, Sweden), 45V DC, 20 mA, PS 40 bar, were used to measure the pressure difference over a distance of 1.3 for 4 MHz transducers.

4.3 Materials

Due to the ease of preparation and use, wide availability and relative low cost, cement based materials are the most commonly used grouts for permeation grouting. In this work, Cementa IC30, a relatively fine cement with a water/cement ratio of 0.6 – 1.0 (by weight), was used. IC30 is a sulphate resistant, chromate reduced and low alkali grouting cement. The largest particle size is 30 microns. A mixing time of 4 minutes was used for all batches. Cementa SetControl II was used as an additive; this is a high performance binding time regulator that is suitable for grouts based on Cementa grouting cements. SetControl II was used to keep conditions similar to those the field.

5 Results

5.1 In-line measurement of the rheological properties of cement grout

The feasibility of using the UVP+PD method to determine the rheological properties of cement grouts depends on the measurement of the velocity profiles. Since it was possible to measure the velocity profiles for w/c ratios down to 0.6, at least up to the center of the pipe, the UVP+PD method was found capable of determining the rheological properties directly in-line under field like conditions. The visualization and shape of the velocity profiles of cement grouts were an important finding, since this is not possible to achieve using any other method and performed for the first time for cement based grouts. Nevertheless, for the w/c ratio of 0.6, the velocity profiles were distorted at the center of the pipe due to the strong attenuation of the ultrasound energy. Moreover, the transducers were installed in cavities into a flow adapter, and clogged cement particles were observed that decreased the penetration length due to the strong attenuation. As a result, a non-invasive, clamp-on type device capable of emitting higher acoustic energy was required.

Rheological properties were determined using the Herschel Bulkley model fitting procedure. This model was chosen since it includes a yield stress and exhibits a shear thinning behavior, which resembles the behavior observed in cement grouts. An expected, a trend of increased yield stress was observed for a thicker suspension, i.e. w/c ratio 0.6. A change in the rheological properties, i.e. increased yield stress and viscosity with time, was observed for w/c ratios of 0.6 and 0.8.

5.2 Change in the rheological properties of cement grout with concentration and time

Since the yield stress and viscosity of cement grout changes with concentration and time, a new study was done to determine the change in the rheological properties directly in-line. A novel non-invasive sensor unit, capable of emitting sufficient acoustic energy, was tested. Velocity profiles were measured for w/c ratios of 0.6-1.0. It was possible to obtain accurate velocity profiles for w/c ratios down to 0.6, as shown in figures 6 and 7.

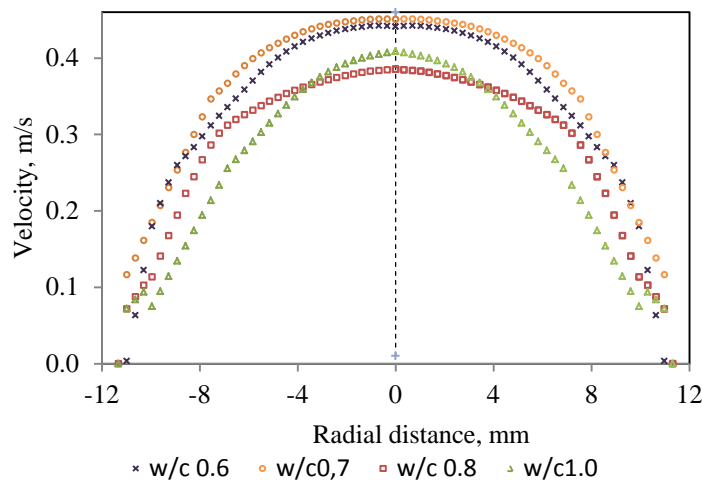

Figure 6 Velocity profiles for w/c ratios of 0.6, 0.7, 0.8 and 1.0 measured by the non-invasive sensor unit

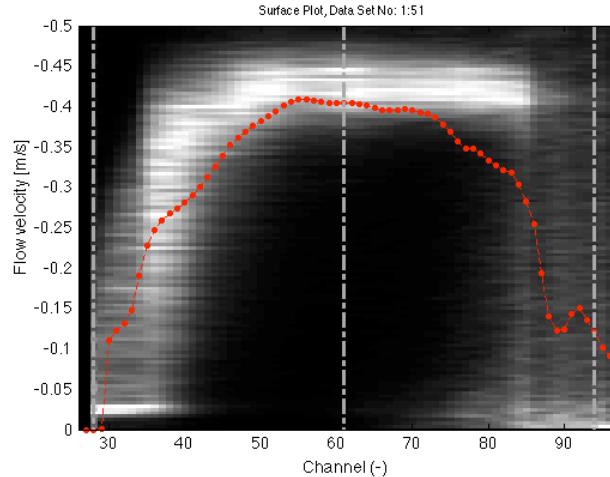

Figure 7 Spectral plot of the velocity profile for w/c ratio 0.7 measured by the non-invasive sensor unit

It can be seen in figure 6 that the velocity profiles were accurately measured, and a plug flow can be seen at the center of the pipe. As a result, the change in the rheology of cement grout due to concentration and time can be visualized directly in-line. It is evident from the shape of the velocity profile that, at higher w/c ratio, e.g. w/c 1.0, the shape of the measured velocity profile indicated that it was fairly Newtonian, in contrast to a lower w/c ratio, where a Bingham behavior is visible. The spectral plot of the velocity profile is shown in figure 7. As can be seen, the velocity profile was measured beyond the center of the pipe, which indicates the improvement in the non-invasive sensor unit in terms of emitting sufficient acoustic energy.

The rheological properties were determined using the Bingham and Herschel-Bulkley models. As expected, an increased yield stress was observed for a higher concentration and with time. In addition to using the rheological models, yield stress and viscosity were determined with non-model approaches, e.g. the gradient method and tube viscometry concept, and are compared. With the gradient method, since no model fitting was used, it is the true rheological behavior that is presented. An increase in the yield stress and viscosity of cement grout was observed. A very high yield stress was observed for the w/c ratio of 0.6. This is expected, however, due to the thicker concentration. Off-line measurements were made with conventional rotational rheometers, and good agreement with the in-line results was found.

5.3 Determination of the volumetric flow rate

The volumetric flow rate was determined by integration of the velocity profiles and this was subsequently compared with the results obtained with the LOGAC and commercial electromagnetic flow meter. As shown in figure 8, for the field grouting rig UNIGROUT E22H, a fluctuation of the flow rate was observed in the UVP; in contrast, the LOGAC yielded results over a fixed order of magnitude. This indicates that the data acquisition rate in UVP is much faster because of the higher pulse repetition frequency and it provides detailed flow behavior of the cement grout in real time. Moreover, UVP is capable of providing an accurate measurement of the flow rate when it is as low as 1 liter/min, which is never possible using the commercial electromagnetic and coriolis flow meters. For the laboratory based

set-up, the progressive cavity pump provided a very stable flow rate. As a result, a similar flow rate was obtained using the UVP, LOGACTM and the commercial electromagnetic flow meter.

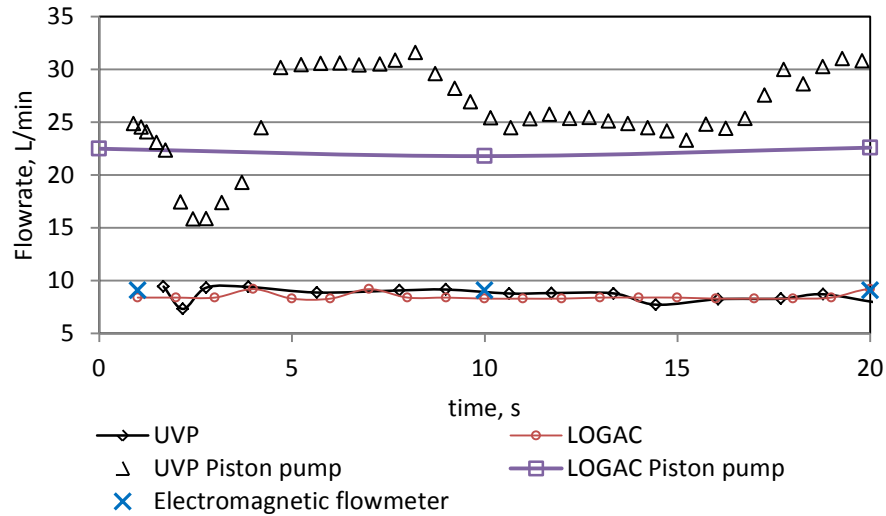

Figure 8 Volumetric flow rate determined by the UVP and measured by the LOGACTM and the electromagnetic flow meter

5.4 Grout pump characteristics

Ultrasound velocity profiling (UVP) was found to be capable of faster data acquisition than the commercial flow meters and measuring instantaneous velocity profiles. As shown in figure 9, 512 profiles were measured over 50 seconds for the w/c ratio of 0.8. The velocity fluctuated from 0.1 m/s to 0.8 m/s, which occurred due to the pulsation of the piston pump. Moreover, a negative velocity was present that was the result of the backstroke of the piston. It is not possible to measure this fluctuation of the velocity profiles with the commercial flow meters. Moreover, the effect of pulsation on the penetration of cement grout inside a rock fracture is as yet unknown. This can be synchronized with the grout pump, and UVP can be an efficient tool to determine the characteristics of the grout pump.

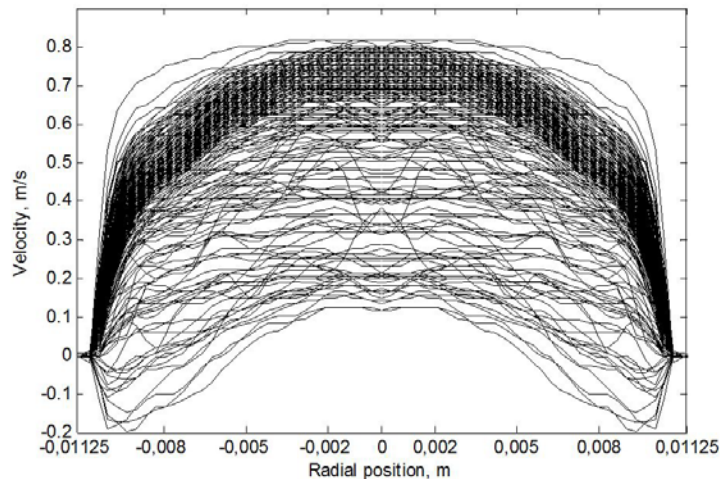

Figure 9 Velocity profiles of w/c ratio 0.8 for piston pump

6 Conclusions and future outlook

The results obtained using the UVP+PD method were found to be very promising for direct in-line determination of the rheological properties of cement based grouts. It was possible to obtain the velocity profiles for w/c ratio down to 0.6 and to determine the rheological properties, such as viscosity and yield stress of the cement grouts. In addition to curve fitting with mathematical models such as Bingham and Herschel-Bulkley, a non-model approach (gradient method) was also applied. It was found that, with the gradient method, the true flow curve (shear stress Vs shear rate) can be obtained. The volumetric flow rate was readily available by integration of the velocity profiles. The conclusions that can be drawn from this study are as follows:

1. It is possible to determine the rheological properties of cement grouts directly in-line under field conditions.
2. It is possible to determine the change of the rheological properties of cement grouts with concentration and time.
3. The yield stress and viscosity of cement grouts can be determined regardless of the rheological model.
4. The non-invasive sensor unit is capable of generating acoustic energy sufficient to measure velocity profiles beyond the center of the pipe.
5. The volumetric flow rate can be accurately determined also when the flow is very low.
6. The grout pump characteristics can be readily visualized.

This is a totally new application of the UVP+PD method for the construction industry, and further research should be carried out to establish the technology in this field. Future work should focus on an accurate determination of the yield stress and investigating different important phenomena such as thixotropy and wall slip. Since wall slip is likely to occur when grout is flowing in circular pipes or in fractured rock, the velocity profile near the pipe wall should thoroughly investigated. The ultimate goal is that this method should be available in the field for continuous determination of the rheological properties and for quality control.

7 References

- Axelsson, M., Gustafson, G., 2006. A robust method to determine the shear strength of cement-based injection grouts in the field. *Tunnelling and Underground Space Technology* 21, 499–503.
- Axelsson, M., Gustafson, G., Fransson, Å., 2009. Stop mechanism for cementitious grouts at different water-to-cement ratios. *Tunnelling and Underground Space Technology* 24, 390–397.
- Banfill, P., 2003. The rheology of fresh cement and concrete - a review. In: proceeding of 11th International Cement Chemistry Congress, Durban.
- Banfill, P., 2006. Rheology of fresh cement and concrete. *Rheology Reviews*, 31–130.
- Barnes, H., Hutton, J., Walters, K., 1989. *An introduction to rheology*. Elsevier.
- Barnes, H., 1995. A review of the slip (wall depletion) of polymer solutions, emulsions and particle suspensions in viscometers: its cause, character and cure. *J. Non-Newtonian Fluid Mech.* 56, 221–231.
- Barnes, H., 1997. Thixotropy—a review. *Journal of Non-Newtonian Fluid Mechanics* 70, 1–33.
- Barnes, H., 1999. The yield stress—a review or 'panta roi'—everything flows?. *Journal of Non-Newtonian Fluid Mechanics* 81, 133–178.
- Barnes, H., Walters, K., 1985. The yield stress myth?. *Rheologica Acta* 24, 323–326.
- Birkhofer, B., 2007. *Ultrasonic In-line characterization of Suspensions - PhD Thesis, Zurich : ETH.*
- Dalmalm, T., 2003. Some aspects on grout time modelling. In: *Proceeding of 3rd International Conference on Grouting and Deep Mixing, ASCE, New Orleans, p. 1466.*
- Draganović, A., Stille, H., 2011. Filtration and penetrability of cement-based grout: Study performed with a short slot. *Tunnelling and Underground Space Technology* 26, 548–559.
- Eklund, D., Stille, H., 2008. Penetrability due to filtration tendency of cement-based grouts. *Tunnelling and Underground Space Technology* 23, 389–398.
- Eriksson, M., Friedrich, M., Vorschulze, C., 2004. Variations in the rheology and penetrability of cement-based grouts—an experimental study. *Cement and Concrete Research* 34, 1111–1119.
- Eriksson, M., Stille, H., Andersson, J., 2000. Numerical calculations for prediction of grout spread with account for filtration and varying aperture. *Tunnelling and Underground Space Technology* 15, 353–364.
- Funehag, J., Fransson, Å., 2006. Sealing narrow fractures with a Newtonian fluid: Model prediction for grouting verified by field study. *Tunnelling and Underground Space Technology* 21, 492–498.
- Funehag, J., Gustafson, G., 2008. Design of grouting with silica sol in hard rock – New methods for calculation of penetration length, Part I. *Tunnelling and Underground Space Technology* 23, 1–8.
- Gustafson, G., Stille, H., 2005. Stop criteria for cement grouting. *Felsbau* 25, 62–68.
- Håkansson, U., Hässler, L., H. Stille, 1992. Rheological properties of microfine cement grouts. *Tunnelling and Underground Space Technology* 7, 453–458.

- Håkansson, U., 1993. Rheology of fresh cement based grouts- PhD Thesis, Stockholm: KTH Royal Institute of Technology, Stockholm.
- Håkansson, U., Rahman, M., 2009. Rheological properties of cement based grouts using the UVP-PD method. In: Proceeding of Nordic Symposium of Rock Grouting, Helsinki.
- Håkansson, U., Rahman, M., Wiklund, J., 2012. In-line measurements of rheological properties of cement based grouts- Introducing the UVP-PD method. In: Proceeding of 4th International Conference on Grouting and Deep Mixing, New Orleans.
- Hässler, L., 1991. Grouting of rock - Simulation and Classification - PhD thesis, Stockholm : KTH Royal Institute of Technology.
- Hässler, L., Håkansson, U., Stille, H., 1992. Computer-simulated flow of grouts in jointed rock. *Tunnelling and Underground Space Technology* 7, 441–446.
- Keating, J., Hannant, D., 1989. The Effect of Rotation Rate on Gel Strength and Dynamic Yield Strength of Thixotropic Oil Well Cements Measured Using a Shear Vane. *Journal of Rheology* 33, 1011–1020.
- Kotzé, R., Haldenwang, R., Slatter, P., 2008. Rheological characterization of highly concentrated mineral suspensions using ultrasonic velocity profiling combined pressure difference method. *Applied Rheology* 18, 62114.
- Kobayashi, S., Stille, H., Gustafson, G., Stille, B., 2008. Real time grouting control method - Development and application using Äspö HRL data (No. R-08-133). Swedish Nuclear Fuel and Waste Management Co, Stockholm.
- Larrard, F., Ferraris, C., Sedran, T., 1998. Fresh concrete: A Herschel-Bulkley material. *Materials and Structures* 31, 494–498.
- Lombardi, G., 1985a. Some theoretical considerations on cement rock grouting. Lombardi Engineering Ltd.
- Lombardi, G., 1985b. The role of cohesion in cement grouting of rock. *Congres des Grandes Barrage*, 58(13).
- Lombardi, G., Deere, D., 1993. Grouting design and control using the GIN principle. *International Water Power and Dam Construction*.
- Mannheimer, R., 1991. Laminar and turbulent flow of cement slurries in large diameter pipe: A comparison with laboratory viscometers. *Journal of Rheology* 35, 113–133.
- Nehdi, M., Rahman, M.A., 2004. Estimating rheological properties of cement pastes using various rheological models for different test geometry, gap and surface friction. *Cement and Concrete Research* 34, 1993–2007.
- Nguyen, Q., Boger, D., 1983. Yield stress measurement for concentrated suspensions. *Journal of Rheology* 27, 321.
- Nguyen, Q., Boger, D., 1985. Thixotropic behaviour of concentrated bauxite residue suspensions. *Rheologica Acta* 24, 427–437.

- Nguyen, Q., Boger, D., 1987. Characterization of yield stress fluids with concentric cylinder viscometers. *Rheologica acta* 26, 508–515.
- Rahman, M., Håkansson, U., Wiklund, J., 2012. Grout pump characteristics evaluated with the Ultrasound Velocity profiling. In: *Proceeding of ISRM International Symposium, EUROCK, Stockholm*.
- Rosquoët, F., Alexis, A., Khelidj, A., Phelipot, A., 2003. Experimental study of cement grout. *Cement and Concrete Research* 33, 713–722.
- Sant, G., Ferraris, C., Weiss, J., 2008. Rheological properties of cement pastes: A discussion of structure formation and mechanical property development. *Cement and Concrete Research* 38, 1286–1296.
- Takeda, Y., 1986. Velocity profile measurement by ultrasound Doppler shift method. *International journal of heat and fluid flow* 7, 313–318.
- Takeda, Y., 1995. Velocity profile measurement by ultrasonic Doppler method. *Experimental thermal and fluid science* 10, 444–453.
- Wallevik, J., 2009. Rheological properties of cement paste: Thixotropic behavior and structural breakdown. *Cement and Concrete Research* 39, 14–29.
- Wiklund, J., Rahman, M., Håkansson, U., 2012. In-line rheometry of micro cement based grouts - A promising new industrial application of the ultrasound based UVP+PD method. *Applied Rheology* 22, 42783.
- Wiklund, J., Kotzé, R., Haldenwang, R., Stading, M., 2012b. Development of an industrial UVP+PD based rheometer- optimisation of UVP system and transducer technology. In: *Proceeding of 8th International Symposium on Ultrasonic Doppler Methods for Fluid Mechanics and Fluid Engineering, Dresden*.
- Wiklund, J., Shahram, I., Stading, M., 2007. Methodology for in-line rheology by ultrasound Doppler velocity profiling and pressure difference techniques. *Chemical Engineering Science* 62, 4277–4293.
- Wiklund, J., Stading, M., 2008. Application of in-line ultrasound Doppler based UVP-PD rheometry method to concentrated model and industrial suspensions. *Flow Measurement and Instrumentation* 19, 171–179.
- Wiklund, J., Stading, M., Pettersson, A., Rasmuson, A., 2006. A comparative study of UVP and LDA techniques for pulp suspensions in pipe flow. *AIChE Journal* 52, 484–495.
- Yahia, A., Khayat, K., 2001. Analytical models for estimating yield stress of high-performance pseudoplastic grout. *Cement and concrete research* 31, 731–738.
- Yahia, A., Khayat, K., 2003. Applicability of rheological models to high-performance grouts containing supplementary cementitious materials and viscosity enhancing admixture. *Materials and Structures* 36, 402–412.